

Mosquito

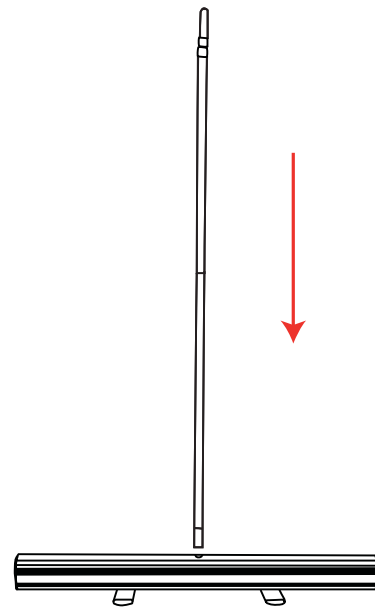

Visible graphic Area: 3000mm(h) x 850/1000/1200/1500/2000mm(w)
Recommended Graphic Thickness: 300 microns

Mosquito

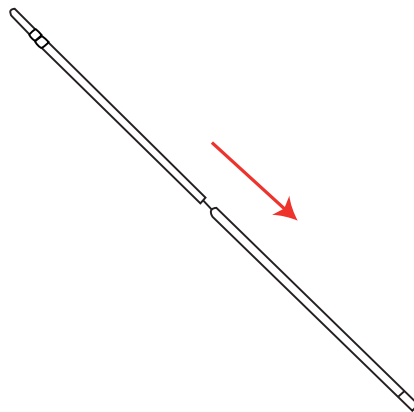
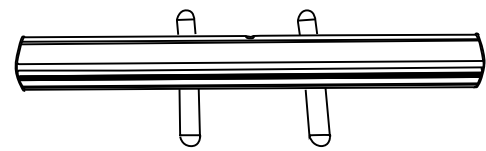
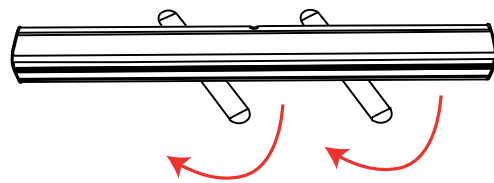
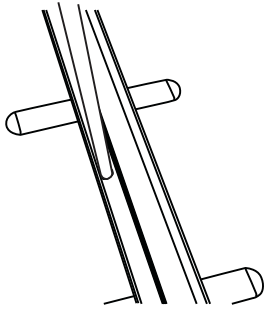

2

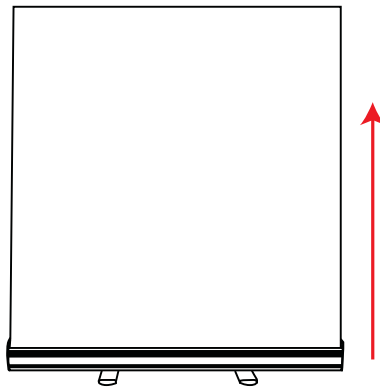

3

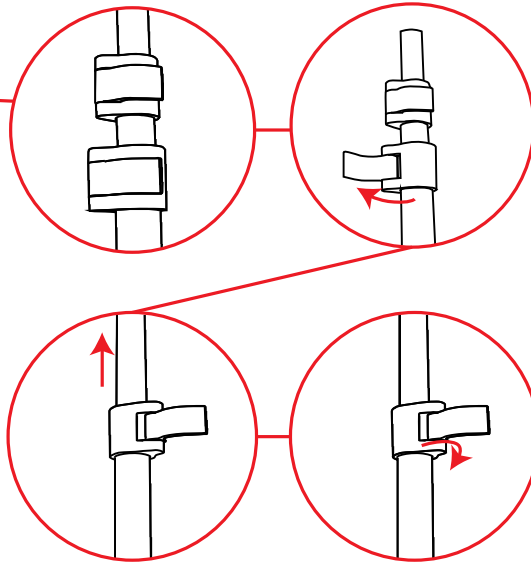
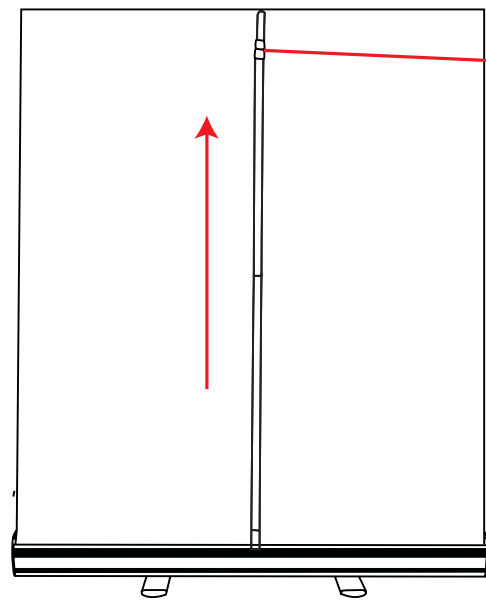
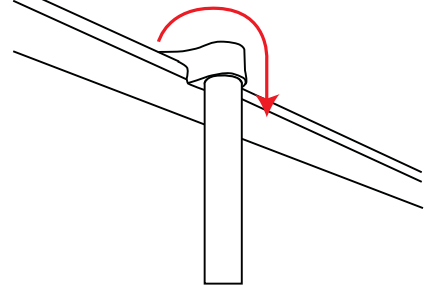

Mosquito

nic

